

PRODUCT CODE: SR40B
EXTENSION RING



DESCRIPTION

40mm Extension Ring

FINISH

Black Enamel

MATERIAL

Steel

PACKAGING

Packed in qty 20

ADDITIONAL NOTES

Conforms to BS EN61386-1

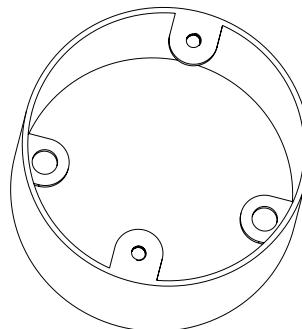

Isometric view

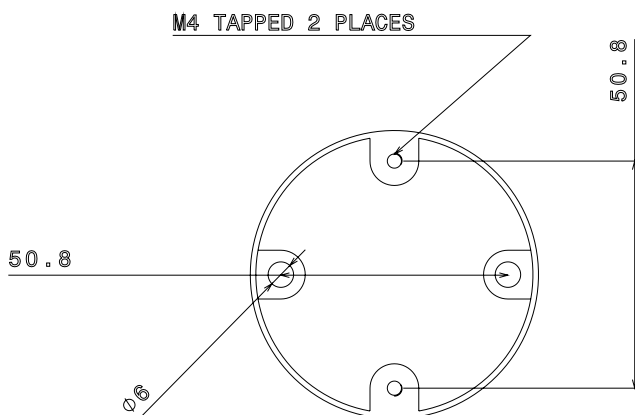

Top view

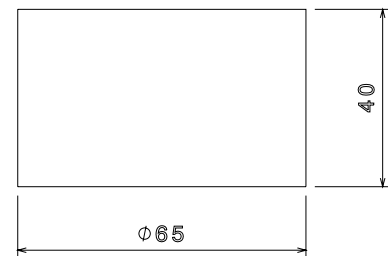

Side view